

marren

Microwave Oven

Model: ISM-1800

Operation Manual



Please read these instructions carefully before using your microwave oven, and retain for safe keeping.

Following these instructions will help to provide you with many years of good service from your microwave oven.

CONTENTS

Important safety instructions	4-8	9. Preset Program Cook Mode	18
Materials you can use in a microwave oven	8	10. On the Fly Cooking	18
Materials you need to avoid in a microwave oven	9	11. Time Defrost Function	19
Setting up your microwave oven	10	12. Programming	19-20
Installation	11	13. Double/Triple Quantity Cooking	20
Cleaning instructions	12	14. Stage Cooking Programming	21
Operation control panel	13	15. Filter Cleaning Function	22
How to operate your microwave oven	13	16. USB Function	22
Appendix A: User options	14	17. Use Option Mode	22-23
Appendix B: Default cook times	15	18. Factory Default Setting	23
1. Power Up	16	How to set and save menu programs on the USB stick	24-25
2. Idle Mode	16	Air Filter Cleaning	26
3. Ready Mode	16	Installation (Supplement)	27
4. Door Open Mode	16-17	Troubleshooting	28
5. Pause Mode	17	Warranty Information	29
6. Manual Cook Entry Mode	17		
7. Manual Cook Mode	18		
8. End of Cycle Mode	18		

PRECAUTIONS TO AVOID POSSIBLE EXPOSURE TO EXCESSIVE MICROWAVE ENERGY

- a. Do not attempt to operate this oven with the door open since this can result in harmful exposure to microwave energy. It is important not to break or tamper with the safety interlocks.
- b. Do not place any object between the oven front face and the door or allow soil or cleaner residue to accumulate on sealing surfaces.
- c. **WARNING:** If the door or door seals are damaged, then the oven must not be operated until it has been repaired by a competent person.

ADDENDUM

If the oven is not maintained in a good state of cleanliness, its surfaces can become degraded and affect the lifespan of the oven potentially, leading to a dangerous situation.

SPECIFICATIONS

Model	ISM-1800
Rated Voltage	230V~240V 50Hz
Max Power input (Microwave)	3000W
Rated Output Power (Microwave)	1800W
Oven Capacity	17.9L
External Dimensions	420 x 563 x 340mm
Net Weight	Approx. 31.6KG

IMPORTANT SAFETY INSTRUCTIONS

WARNING

To reduce the risk of fire, electric shock, injury to persons or exposure to excessive microwave oven energy when using your appliance, follow basic precautions, including the following:

1. This appliance is not intended for use by persons (including children) with reduced physical, sensory or mental capabilities, or lack of experience and knowledge, unless they have been given supervision or instruction concerning use of the appliance by a person responsible for their safety. Children should be supervised to ensure that they do not play with the appliance.
2. If the supply cord is damaged, it must be replaced by the manufacturer, its service agent or qualified persons in order to avoid a hazard. (For appliance with type Y attachment)
3. WARNING: Ensure that the appliance is switched off before replacing the lamp in order to avoid the possibility of electric shock.
4. WARNING: It is hazardous for anyone other than a competent person to carry out any service or repair operation that involves the removal of a cover which gives protection against exposure to microwave energy.
5. WARNING: Liquids and other foods must not be heated in sealed containers, as they are liable to explode.
6. WARNING: Microwave heating of beverages can result in delayed eruptive boiling, therefore care must be taken when handling the container.
7. WARNING: The contents of feeding bottles and baby food jars should be stirred or shaken and the temperature checked before consumption, in order to avoid scalding.
8. Only use utensils that are suitable for use in a microwave oven.
9. When heating food in plastic or paper containers, keep an eye on the oven due to the possibility of ignition.
10. If smoke is observed, switch off or unplug the appliance and keep the door closed in order to stifle any flames.

11. Eggs in their shell and whole hard-boiled eggs should not be heated in microwave ovens since they may explode, even after microwave heating has ended.
12. The oven should be cleaned regularly and any food deposits should be removed.
13. The appliance must not be cleaned with a water jet. (For appliances intended to stand on the floor and which are not at least IPX5)
14. Failure to maintain the oven in a clean condition could lead to deterioration of the surfaces that could adversely affect the life of the appliance and possibly result in a hazardous situation.
15. Only use the temperature probe recommended for this oven. (For ovens provided with a facility to use a temperature-sensing probe.)
16. Read and follow the specific: “PRECAUTIONS TO AVOID POSSIBLE EXPOSURE TO EXCESSIVE MICROWAVE ENERGY”.
17. Metallic containers used for food and beverages are not allowed during microwave cooking.

READ CAREFULLY AND KEEP FOR FUTURE REFERENCE

TO REDUCE THE RISK OF INJURY TO PERSONS GROUNDING INSTALLATION

WARNING ELECTRIC SHOCK HAZARD

Touching internal components can cause serious personal injury or death. Do not disassemble this appliance.

This appliance must be grounded. Improper use of the grounding can result in electric shock. Do not plug into an outlet until the appliance is properly installed and grounded.

In the event of an electrical short circuit, grounding reduces the risk of electric shock by providing an escape wire for the electric current. This appliance is equipped with a cord, grounding wire and a grounding plug. The plug must be plugged into an outlet that is properly installed and grounded.

CONSULT A QUALIFIED ELECTRICIAN OR SERVICEMAN

If the grounding instructions are not completely understood or if doubt exists as to whether the appliance is properly grounded.

CLEANING

Be sure to unplug the appliance from the power supply.

1. Clean the cavity of the oven after using with a slightly damp cloth.
2. Clean the accessories in the usual way in soapy water.
3. The door frame, seal and neighbouring parts must be cleaned carefully with a damp cloth when they are dirty.
4. Do not use harsh abrasive cleaners or sharp metal scrapers to clean the oven door glass, as they can scratch the surface, which may result in shattering of the glass.
5. Cleaning Tip - For easier cleaning of the cavity walls in which cooked food can touch: Place half a lemon in a bowl, add 300ml (1/2 pint) of water and heat on 100% microwave power for 10 minutes. Wipe the oven clean using a soft, dry cloth.

UTENSILS CAUTION PERSONAL INJURY HAZARD

It is hazardous for anyone other than a competent person to carry out any service or repair operation that involves the removal of a cover which gives protection against exposure to microwave energy.

See the instructions on “Materials you can use in a microwave oven or to be avoided in a microwave oven.” There are certain non-metallic utensils that are unsafe to use for microwaving. If in doubt, you can test the utensil in question following the procedure on page 8.

UTENSIL TEST

1. Fill a microwave-safe container with 1 cup of cold water (250ml), along with the utensil in question.
2. Cook on maximum power for 1 minute.
3. Carefully feel the utensil. If the empty utensil is warm, do not use it for microwave cooking.
4. Do not exceed a minute of cooking time.

MATERIALS YOU CAN USE IN MICROWAVE OVEN

Utensils	Remarks
Dinnerware	Microwave-safe only. Follow manufacturer's instructions. Do not use cracked or chipped dishes.
Glass Jars	Always remove lid. Use only to heat food until just warm. Most glass jars are not heat resistant and may break.
Glassware	Heat-resistant oven glassware only. Make sure there is no metallic trim. Do not use cracked or chipped dishes.
Oven Cooking Bags	The manufacturer's instructions. Do not close with a metal tie. Make slits to allow steam to escape.
Paper Plates and Cups	Use for short-term cooking/warming only. Do not leave oven unattended while cooking.
Paper Towels	Use to cover food for reheating and absorbing fat. Use with supervision and a short-term cooking only.
Parchment Paper	Use as a cover to prevent splattering or a wrap for steaming.
Plastic	Microwave-safe only. Follow the manufacturer's instructions. Should be labelled "Microwave Safe". Some plastic containers soften, as the food inside gets hot. "Boiling bags" and tightly closed plastic bags should be slit, pierced or vented as directed by package.
Plastic Wrap	Microwave-safe only. Use to cover food during cooking to retain moisture. Do not allow plastic wrap to touch food.
Thermometers	Microwave-safe only (meat and candy thermometers).
Wax Paper	Use as a cover to prevent splattering and retain moisture.

MATERIALS TO BE AVOIDED IN MICROWAVE OVEN

Utensils	Remarks
Aluminium Tray	May cause arcing. Transfer food into microwave-safe dish.
Food Carton with Metal Handle	May cause arcing. Transfer food into microwave-safe dish.
Metal or Metal Trimmed Utensils	Metal shields the food from microwave energy. Metal trim may cause arcing.
Metal Twist Ties	May cause arcing and could cause a fire in the oven.
Paper Bags	May cause a fire in the oven.
Plastic Foam	Plastic foam may melt or contaminate the liquid inside when exposed to high temperature.
Wood	Wood will dry out when used in the microwave oven and may split or crack.

SETTING UP YOUR MICROWAVE OVEN

NAMES OF OVEN PARTS AND ACCESSORIES

Remove the oven and all materials from the carton and oven cavity. Your oven comes with the following accessories:

Instruction Manual

- a. Control panel
- b. Observation window
- c. Safety interlock system
- d. Ceramic board
- e. Air Filter
- f. Plug
- g. Ventilation

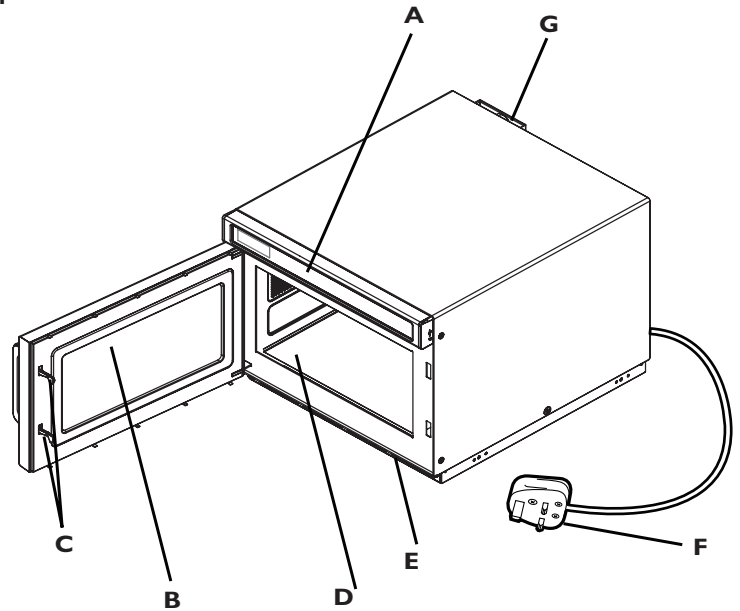

NOTE:

1. Do not forcibly press the ceramic board.
2. Take out the utensils gently during operation to avoid damage to the ceramic board.
3. Immediately after using, do not touch the ceramic board by hand in order to avoid a high temperature scald.

COUNTERTOP INSTALLATION

Remove all packing material and accessories. Examine the oven for any damage such as dents or broken door. Do not install if the oven is damaged.

Cabinet: Remove any protective film found on the microwave oven cabinet surface.

INSTALLATION

1. Select a level surface that provides enough open space for the intake and/or outlet vents. (Fig 1)

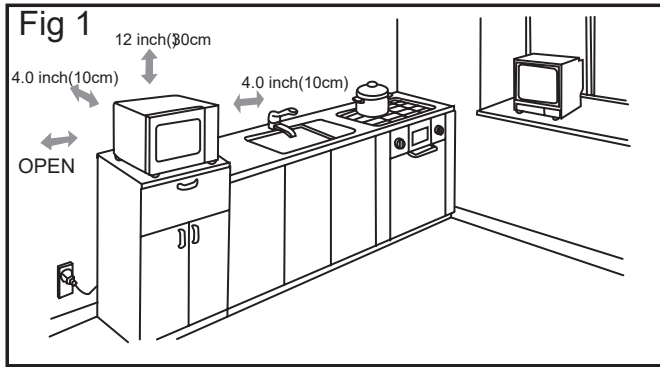

A 10-cm spacing should be kept between the appliance's and right and back walls, and a 30-cm spacing kept on the top. Never dismantle the appliance's feet, nor block the air intake and exhaust opening. The left side must be open.

- 1) Blocking the intake and/or outlet openings can damage the oven.
- 2) Place the oven as far away from radios and TV as possible. Operation of the microwave oven may cause interference to your radio or TV reception.
- 3) Plug your oven into a standard household outlet. Be sure the voltage and the frequency are the same as the voltage and the frequency on the rating label.
- 4) **WARNING:** The plug socket, electric appliance or any other appliance affected by heat and moisture should be kept away from the vents on the oven.

2. Stacking and installation of the microwave oven.

The maximum height of stacking shall be two layers. Specific stacking installation is as follows.

- (A) Unscrew and remove the mounting plate, and then tighten the screws.
- (B) Remove the four screws as shown in (Fig 2).
- (C) Mount the mounting plate to the lower position and fix the screws that are just loosened.

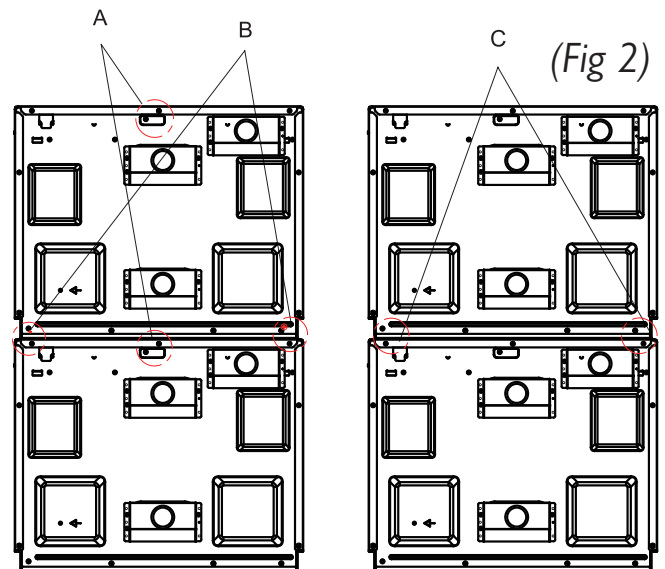

CLEANING INSTRUCTIONS

ALWAYS KEEP THE MICROWAVE OVEN CLEAN

1. Cleaning the glass viewing window, the inner door panel and oven front face. For best performance and to maintain a higher degree of safety, the inner door panel and oven front face should be free of food or grease build-up. Wipe these parts with a mild detergent, rinse and wipe dry. Never use abrasive powders or pads.

2. Cleaning the control panel and plastic parts. Do not apply a detergent or an alkaline liquid spray to the control panel and plastic parts, as this may cause damage to these parts. Use a dry cloth (not a soaked cloth) to clean these parts.

3. Cleaning the oven interior. After use be sure to clean up any spilt liquids, spattered oil or food debris, as quickly as possible. If the oven is used whilst dirty, the efficiency may drop. Dirt stuck to the oven surfaces may cause bad odours. Clean the interior with a cloth, soaked in luke-warm water with a mild detergent mix, then rinse the soap off with a damp cloth.

4. Cleaning the roof liner regularly, will help prevent food debris and oils from dropping on to food, that has been placed in the cavity for heating.

5. Cleaning the air filter regularly, will keep it clear. The appliance will over heat when the air filter is blocked.

6. When the appliance is operated, the roof liner and air filter must be correctly in place in order to avoid damage to other parts/components (See installation on page 26).

CAUTION: Do not wipe plastic and painted sections of the oven with bleach, thinners or other cleaning agents, as this may cause these parts to dissolve or become sharp.

OPERATION CONTROL PANEL (WITH BRAILLE) AND FEATURES

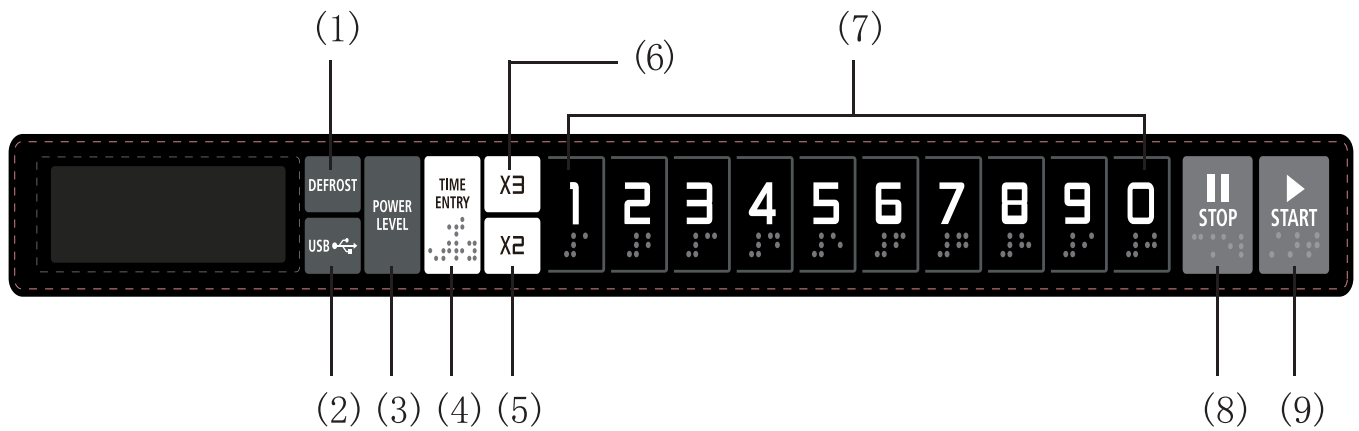

- (1) Defrost Button
- (2) USB Buttons
- (3) Power Level Button
- (4) Time Entry Button
- (5) Double Quantity Button
- (6) Triple Quantity Button
- (7) Number Buttons
- (8) Stop/Reset Button
- (9) Start Button

OPERATION INSTRUCTION

APPENDIX A USER OPTIONS

Items in bold below are the default values.

Option	Setting	Description
1 EOC Tone	OP:10	3 SECONDS BEEP
	OP:11	Continuous Beep
	OP:12	5 quick beeps, Repeating
2 Beeper Volume	OP:20	Beeper Off
	OP:21	Low
	OP:22	MEDIUM
	OP:23	High
3 Beeper On/Off	OP:30	Keybeep Off
	OP:31	KEYBEEP ON
4 Keyboard Window	OP:40	15 Seconds
	OP:41	30 Seconds
	OP:42	60 SECONDS
	OP:43	120 Seconds
5 On the Fly	OP:50	On-the-Fly Disabled
	OP:51	ON-THE-FLY ENABLED
6 Door Reset	OP:60	DOOR RESET DISABLED
	OP:61	Door Reset Enabled
7 Max Time	OP:70	60 MINUTE MAXIMUM COOK TIME
	OP:71	10 Minute Maximum Cook Time
8 Manual Programming	OP:80	Manual Programming Disabled
	OP:81	MANUAL PROGRAMMING ENABLED
9 Double Digit	OP:90	SINGLE DIGIT MODE-10 PROGRAMS
	OP:91	Double Digit Mode-100 Programs
0 Clean Filter	OP:00	Off-Never Display Clean Filter
	OP:01	Weekly-Display every 7 days
	OP:02	MONTHLY-DISPLAY EVERY 30 DAYS
	OP:03	Quarterly-Display every 90 days

OPERATION INSTRUCTION

APPENDIX B DEFAULT COOK TIMES

The oven will with operate with the following Preset Cook Times, unless otherwise noted in the product Specification.

Button	Display (Time)	Power
1	0:10	100%
2	0:20	100%
3	0:30	100%
4	0:45	100%
5	1:00	100%
6	1:30	100%
7	2:00	100%
8	2:30	100%
9	3:00	100%
10	3:30	100%

OPERATION INSTRUCTION

1. POWER UP

When the oven is turned on for the first time, “----- “ will display. If the “ “ button is pressed, the oven will change to idle mode.

Note: During idle mode, the oven will not respond when buttons are pressed.

2. IDLE MODE

1) The oven will enter idle mode after a set of seconds have elapsed in Ready Mode without a keyboard press or a door open and close. The number of seconds is determined by the keyboard Timeout Window, set by User Option 4.

2) During idle mode, the screen is blank with no oven activity.

3) Opening and then closing the oven door, will exit idle mode and will then enter into ready mode.

Note: During idle mode, any button press will provide no response. If the “ “ button is pressed, the buzzer will ring once and there will be no oven activity.

3. READY MODE

1) In this mode, the oven is ready to either begin a manual or preset cook cycle.

2) Opening and closing the door while the oven is in Idle Mode will put the oven into Ready Mode.

3) During Ready Mode, “READY” will display.

4) From the Ready Mode, the oven can go to almost all of the other modes.

4. DOOR OPEN MODE

1) While the door of the oven is open, the oven will be in Door Open Mode.

2) During this mode, the screen is blank. If the door is open during the cooking state, “DOOR” and “OPEN” will display once, in order. The screen will then display the remaining cooking time and the fan and oven lamp will function.



3) When the door is closed, the oven will enter Ready Mode.

Note: When the door is open, if User Option OP:60 is selected and the oven is running a manual or preset cook cycle, the oven will enter Pause Mode.



OPERATION INSTRUCTION

In all other cases, the oven will return to Door open Mode with User Option OP:61 set. Opening and closing the door will clear out any information about a Manual or Preset Program which was running.

5. PAUSE MODE



- 1) This mode allows the users to temporarily stop the cooking cycle to inspect or stir the food item.
- 2) While in Manual Cook Mode or Preset Program Cook Mode, if the door is open and then closed, or if the “” pad is pressed, the oven will enter Pause Mode.
- 3) While paused, the screen will display the remaining cooking time.
- 4) Pause Mode will revert back to Idle Mode in the exact fashion as Ready Mode, dependent on User Option 4. Additionally, if the “” button is pressed, the oven will immediately enter Ready Mode or if the “” button is pressed, the oven will go into working mode.

6. MANUAL COOK ENTRY MODE

- 1) The user may manually enter a cook time and power level whilst in this mode.
- 2) While the oven is in the Ready Mode, pressing the “Time Entry” pad on the keyboard will put the oven into Manual Cook Entry Mode.
- 3) During this mode, “00:00” displays. At this point, you can input the time required.
- 4) Press “Power Level” button, “%POWER” displays. Press the number buttons to select the power level you require, and the corresponding power will light. If you want to choose full power level, press “1” and “0” in succession, then the screen will display “%POWER”. If no power level is chosen, 100% power is the default.
- 5) During the setting process, press “” to enter Manual Cook Mode. Press “” to enter Ready Mode.

OPERATION INSTRUCTION

7. MANUAL COOK MODE

- 1) This mode allows manual cooking of food items. While in Manual Cook Entry Mode, pressing the “” pad will begin Manual Cook Mode.
- 2) During this mode, the remaining cooking time displays. The fan and oven lamp will light.
- 3) When the cooking program finishes, the oven will enter End of Cook Cycle Mode. If you press the “” button under this mode, the oven will enter Pause Mode.

8. END OF CYCLE MODE

- 1) After the cooking time has expired in a Manual Cook Mode, or a Preset Program Cook Mode, the oven will go into the End of Cook Cycle Mode.
- 2) During this mode, “DONE” displays.
- 3) If either User Option OP:11 or OP:12 is selected, the oven will continue to sound until the user acknowledges this by either opening and closing the door or pressing the “” button. If User Option OP:10 is selected, after the 3 second beep, the oven will display “DONE”. After the beep, “READY” will display and the oven will enter Idle Mode without any operation for a period of time.

9. PRESET PROGRAM COOK MODE



- 1) This mode allows cooking of food items through a one pad touch operation. While in Ready Mode, pressing a number buttons will initiate the Preset Program associated with that number button.
- 2) During this mode, the screen will display the remaining cooking time. If it's multi-stage cooking, the total remaining cook time is displayed, not the particular stage of cooking.
- 3) When cooking program finishes, the oven will enter End of Cook Cycle Mode. If you press the “” button under this mode, the oven will enter Pause Mode.

10. ON THE FLY COOKING

- 1) While the oven is cooking, if User Option OP:51 is selected, the preset cooking programs will start automatically when pressing the number buttons.
- 2) The screen displays the remaining cooking time.
- 3) When the cooking program finishes, the oven will enter End of Cook Cycle Mode.

OPERATION INSTRUCTION

11. TIME DEFROST FUNCTION



- (1) In Ready Mode, press “DEFROST” button, the screen will display “00.00”.
- (2) Press number buttons to input defrosting time. The maximum time is 99 minutes and 99 seconds.
- (3) Press “” to start defrosting. The default power is a power level of 20%.
- (4) The remaining cooking time will be displayed. When the cooking program has finished, the oven will enter End of Cook Cycle Mode. If the “” button is pressed during this mode, the oven will enter Pause Mode.

12. PROGRAMMING MODE

This mode allows the user to assign cook times and power levels with a single touch of a button.

- 1) Open the door and press “1” pad for 5 seconds, the buzzer will sound once and enter to Programming Mode.
- 2) “PROGRAM” displays.
- 3) Setting Program: Press a number button to set the program. Two seconds later, the screen will display the time associated with that number button.
- 4) Inputting the time: Press the relevant number buttons to input time.
- 5) Press “POWER LEVEL” button, “%POWER” displays. Press the relevant number buttons to select power level you want, and the corresponding power will light. If you want to choose full power level, press “1” and “0” in succession, then the screen will display “%POWER”. If no power is chosen, 100% power is the default.

Note: Set the time first, then choose the power level.

- 6) After setting the time and power level, press the “”, and the cooking program will be saved. Once the program has been saved, “PROGRAM” will display.
- 7) If all the complete cooking time exceeds the MAX time as per User Option 7, then after pressing the “” button to save the program, the buzzer will sound three times briefly to warn you that the time can not be set and then the screen will turn back to display “PROGRAM”. The time set will not be saved.

OPERATION INSTRUCTION

8) Close the oven door, to return to Ready Mode. If the “” button is pressed during the setting process, the oven will turn to Door Open Mode. The program that did not save will be lost. If there is a saved program within the memory procedure, pressing the relevant number button will start the program. If there is no saved program, the buzzer will alarm when pressing the number button and the program will not start.

For example: To set the program as memory cooking, power level 70% and cooking time as 1 minute and 25 seconds.

Step 1: Open the door, press number button “1” for 5 seconds, “PROGRAM” displays.

Step 2: Press number button “3”, the screen will display “P:03”. After two seconds, the screen will display the related time “:30”.

Step 3: Press number buttons “1”, “2” and “5” to input the cooking time.

Step 4: Press “7” button, “1:25 70” displays. Setting finished.

Step 5: Press “” to save. When using the program next time, just press “3”, and the related program will start.

Note:

1. If the electricity is cut off, the saved program will not be lost.
2. If the program needs to be reset, just repeat the above steps.
3. If “” is pressed at the last step, the oven will turn back to Ready Mode. The setting will not be saved.

13. DOUBLE/TRIPLE QUANTITY COOKING

1) If the “X2” or “X3” button is pressed in Ready Mode, followed by the start of a Preset Program, or if the “X2” or “X3” button is pressed within 5 seconds of starting a Preset Program, the oven will start cooking with the quantity preset cooking time.

2) Press “X2”, “DOUBLE” displays. Press “X3”, “TRIPLE” displays. When pressing the number buttons, the screen will display the quantity preset time. For example, number button “5” and its preset time is 1 minute. Pressing “X2”, will change the time to $1:00 * 2 = 2$ (2 minutes).

3) When cooking program finishes, the oven will enter End of Cook Cycle Mode.

14. STAGE COOKING PROGRAMMING

This allows the user to cook food items in manual cook mode and programming mode.

- 1) A maximum of three stages can be set at most during cooking mode or programming mode. After setting the power and time for the first stage, press “Time Entry” to set the second stage, then the same step to set the third stage.
- 2) When setting the second, third stage, press “ Time Entry”, “STAGE-2”, ”STAGE-3” displays.
- 3) Press “” button to start cooking.

Example: In programming mode, press number buttons “3” to set two stages of cooking. The first stage is PL7 and time is 1 minute 25 seconds. The second stage is PL5 and 5 minutes and 40 seconds. The steps are as follows:

- a. Open the door, press number button “1” for 5 seconds, “PROGRAM” displays.
- b. Press number button “3”, and the screen will display “P:03”. After two seconds, the screen will display the related time “ :30”.
- c. Press “1”, “2”, “5” to input the cooking time. “1:25” displays.
- d. Press “Med-Hi 70%”, “1:25 70” displays. The first stage is finished.
- e. Press “Time Entry”, “STAGE-2” displays.
- f. Press “5”, “4”, “0” button, “5:40” displays.
- g. Press “Medium 50%”, “5:40 50” displays.
- h. Press the “” button to start cooking.
- i. The total time counts down.

OPERATION INSTRUCTION

15. FILTER CLEANING FUNCTION

(1) If User Option OP:01 is set and the cleaning reminder is due, the oven will remind the user to clean the filter.

Note: The oven must be turned on.

(2) The screen will display “CLEAN FILTER” when due. Pressing the “” button or opening the door will put the oven into Ready Mode.

(3) If you do not need to clean the filter, press the “” button and hold for 3 seconds to clear the reminder information. Otherwise, the oven will remind you continually during Idle Mode.

16. USB FUNCTION

(1) During Ready Mode, insert the USB stick with saved “UTABLE” file.

(2) Press the “USB” button to update the data to the computer board. “LOADING” will now display.

(3) If the update is successful, the screen will display “SUCCESS”. Otherwise, “FAIL” will display.

(4) Press the “” button or open the door to finish.

17. USE OPTION MODE

This allows the user to choose between various ways for the microwave oven to operate.

(1) Open the oven door and press the “2” pad for 5 seconds. The buzzer sounds once and enters into this mode.

(2) The screen will display “OP: - -”.

(3) Press any number button to enter the related mode setting.

Example: to set the volume of the buzzer to medium. Press “2”, “OP:22” will display. If you wish to change this, keep pressing “2” and the screen will display “OP:20”, “OP:21”, “OP:22”, “OP:23”, “OP:20” ...in cycle.

(4) Press the “” button to save the current setting. After saving, “OP: - -” will display again.



OPERATION INSTRUCTION

(5) During the setting process, press the “” button to enter Door Open Mode. Closing the door will enter Ready Mode.

6) If the “” button is not pressed at the last step, the program will not be saved but will remain at the previous setting.

18. FACTORY-DEFAULT SETTING

In the Ready Mode, press “” and “0” to revert to factory-default settings.

1) Press “” and “0”, and the buzzer will sound once, the screen will then display “CHECK”. If it has set to factory-default settings then the screen will display “11” after three seconds, and the oven will turn to the ready mode. Press “” to cancel the display and back to ready back in the process of display.

If the oven has not returned to the factory-default setting, the screen will display “00”, press the “” button to the factory-default setting, then the screen will display “CLEAR” and the buzzer will sound once, after self-testing, the screen will display “11” or “00”.

2) If you do not press the “” button when the screen displays “00”, the setting will cancel.

Note: Be careful during this operation as it will restore all configurations to factory-default settings.

HOW TO SET AND SAVE MENU PROGRAMS ON THE USB STICK

1. Insert the USB stick in to the computer and open the file called “Setup”.



2. Double-click “MenuEdit” to enter the editable interface. (Recommendation: Right-click and choose “Run as administrator”)

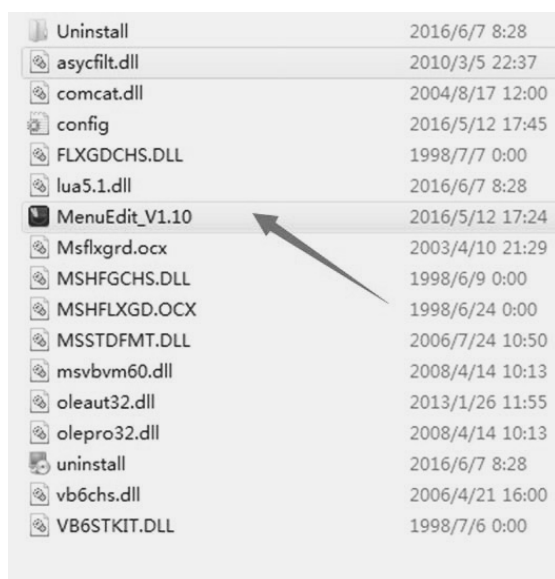

3. Set the maximum cooking time of single menu.

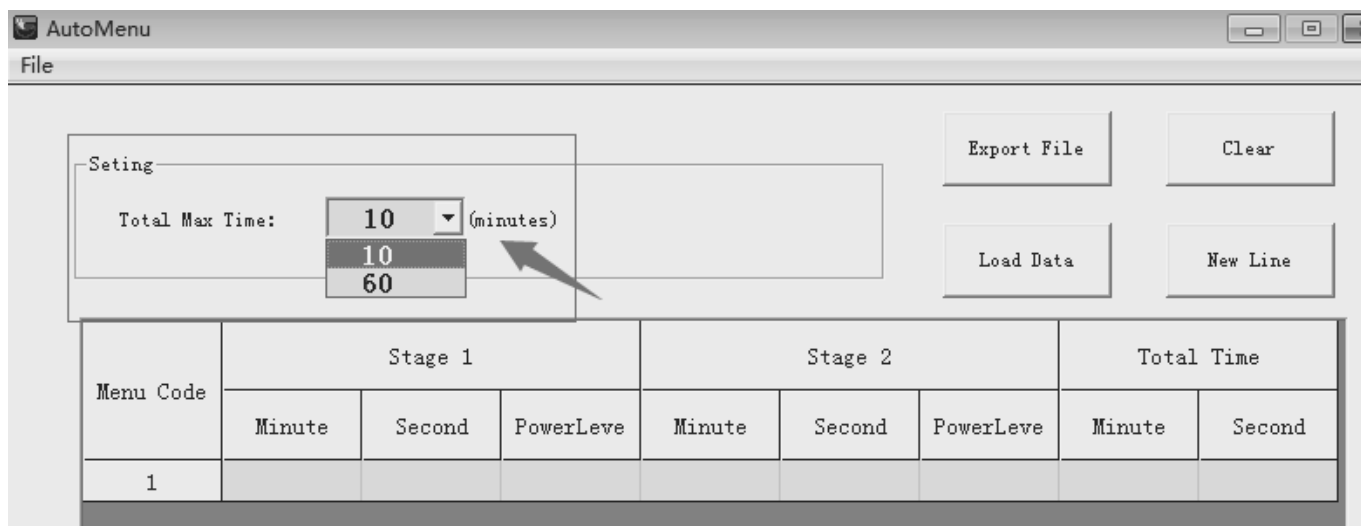

HOW TO SET AND SAVE MENU PROGRAMS ON THE USB STICK

4. Set the first menu A maximum of two stages of cooking can be set. Cooking time and power can also be set.

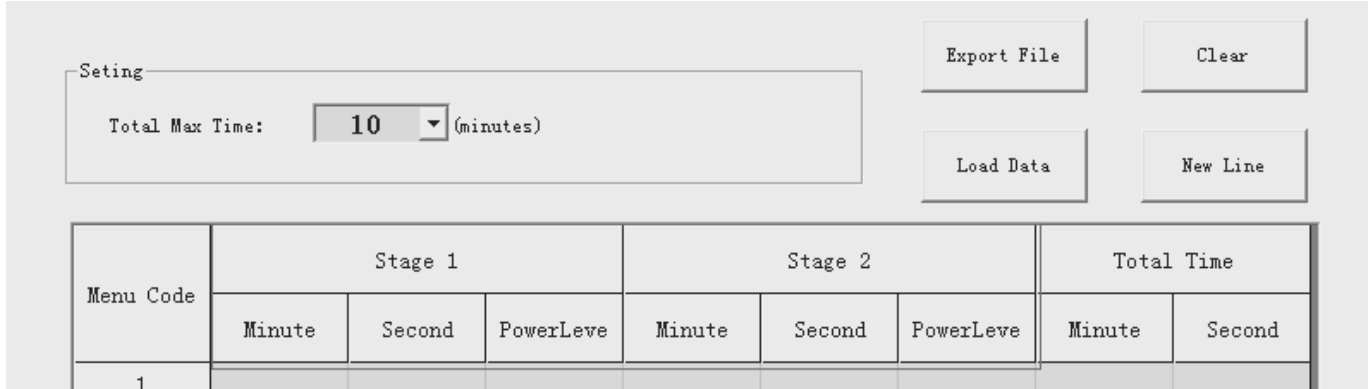

5. Click “New Line” to create the second menu - with a maximum amount of menus being 20.

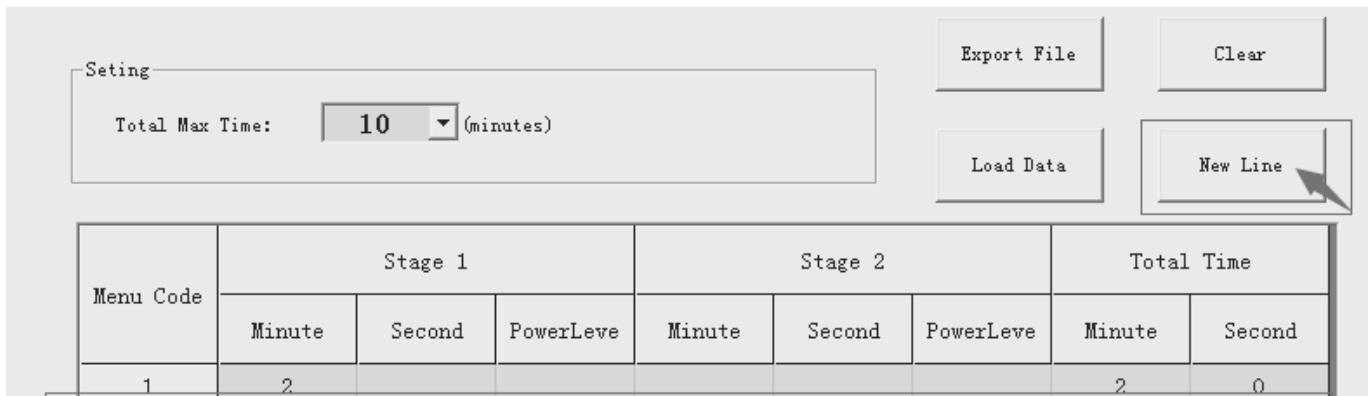

6. Click “Export File” to export the file to USB stick and the file will be named “UTABLE.C”. Click “save” to finish the setting.

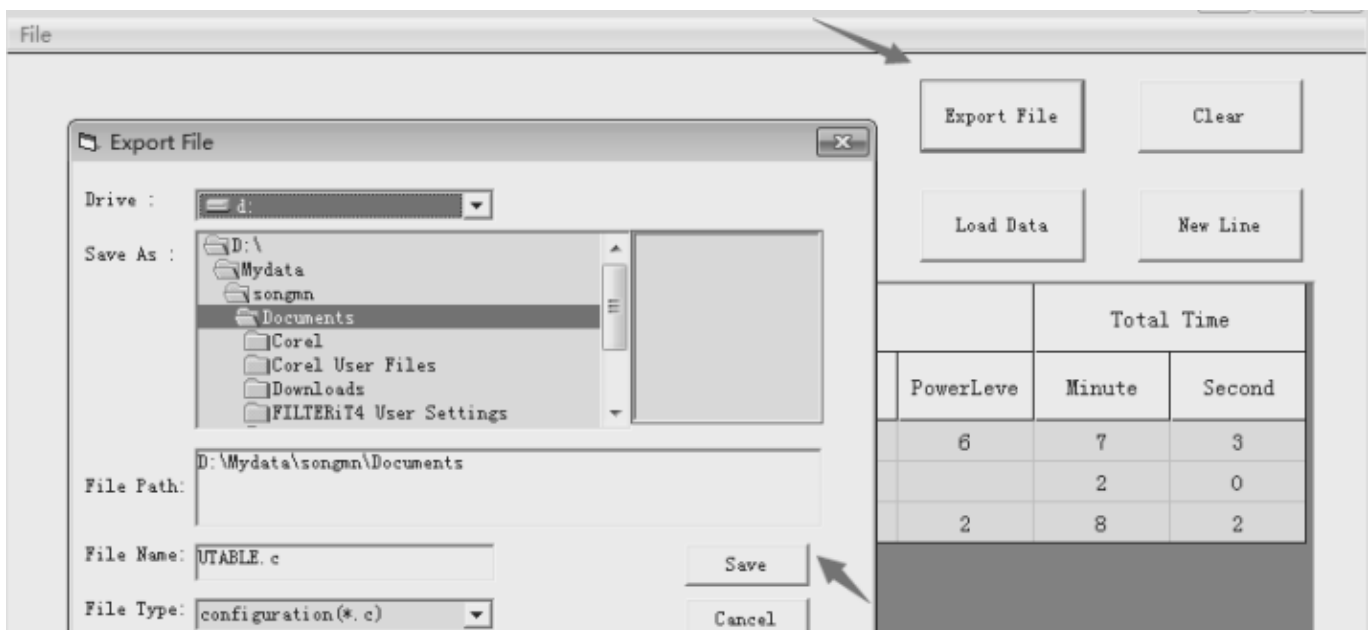

FILTER CLEANING

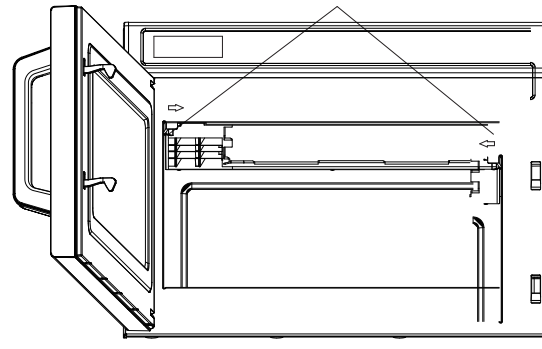
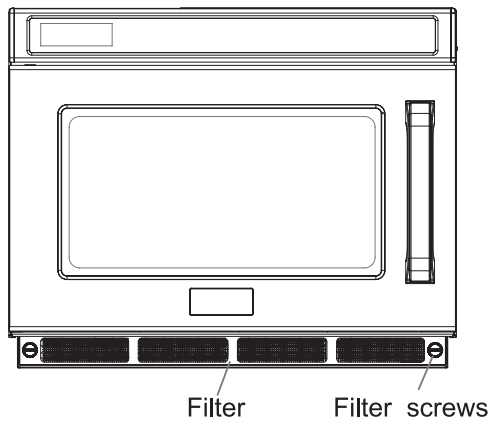

Caution! Make sure the roof liner is installed correctly before use of the microwave oven!

The front air filter serves as the air inlet; the air filter should be cleaned regularly to keep the chamber clean.

1. Turn counterclockwise to unscrew and take down the filter and wash with warm soapy water.
2. Install the air filter screen and tighten the screws clockwise to fix the air filter.
3. Make sure the air filter is installed before using the microwave oven.
4. The factory setting has a function to remind the user to wash the air filter every 30 days.
5. Roof liner cleaning
 - a) Removal: Hold the two buckle positions in front of the roof liner with your hands (as shown by the arrows). Exert your strength following the direction of the arrows and pull downwards after you have pulled out the buckles.
 - b) Wash the roof liner.
 - c) Re-installation: Pick up the roof liner and place horizontally into the chamber in a way that the first pin at the rear is in alignment to the hole on the rear plate of the chamber, then push the other side to insert the positioning pins into their positioning holes.

INSTALLATION (SUPPLEMENT)

1. The switching operation of this microwave oven can cause fluctuations in the supply voltage. The operation of this unit with Voltage supplies of under 225Vac or above 245Vac may cause the oven to not operate correctly. This oven is intended for connection to a power supply that is suitably earthed/grounded and is supplied with a cord and plug to ensure this. The maximum Z_e of the power supply should be correct to local electrical regulations. The power supply cable & protection device must also be suitably rated in line with local electrical regulations, when circuit breakers are used a D type must be fitted to stop nuisance activations.

The user must ensure that this device is connected only to a power supply system which fulfils the requirement above.

2. The oven should be suitably bonded using the bonding connection point on the rear of the unit to local external metal surfaces, this will ensure electric shock is not incurred due to differences in potential. The Bonding connection point is located on the rear of the unit and is indicated by the symbol below:



Symbol for the external connection of equipotential bonding conductors.

TROUBLESHOOTING

Normal	
Microwave oven interfering TV reception	Radio and TV reception may be interfered when microwave oven is operating. It is similar to the interference of small electrical appliances, like mixers, vacuum cleaners and electric fans. This is normal.
Dim oven light	In low power microwave cooking, oven light may become dim. This is normal.
Steam accumulating on door, hot air out of vents	In cooking, steam may come out of food. Most will get out from vents. But some may accumulate on cool places like oven door. This is normal.
Oven started accidentally with no food in	It is forbidden to run the unit without any food inside. This is very dangerous.

Trouble	Possible Cause	Remedy
Oven will not turn on	Power cord not plugged in tightly	Unplug, then plug in again after 10 seconds
	(2) Fuse blowing or circuit breaker tripping	Replace fuse or reset circuit breaker (repaired by professional personnel of our company)
	(3) Trouble with outlet	Test outlet with other electrical appliances
Oven does not heat	(4) Door does not close well	Close door well



According to Waste of Electrical and Electronic Equipment (WEEE) directive, WEEE should be separately collected and treated. If at any time in future you need to dispose of this product please do NOT dispose of this product with household waste. Please send this product to WEEE collecting points where available.

WARRANTY CONDITIONS & EXCLUSIONS

Marren warrants to the original purchaser that the microwave is free from defects in materials and workmanship. The warranty will thereby commence from the (“Original Purchase Date”) and expire 3 years after.

Any components or parts of the microwave which proves to be defective in material or workmanship within 3 years of the original date of purchase, will be replaced or repaired by an authorised engineer, without cost to the original purchaser, except for the following exclusions.

EXCLUSIONS

- a) Cosmetic damage, including scratches and dents incurred during use.
- b) Any fault or repairs needed due to misuse or neglect of the appliance.
- c) Costs related to the removal, installation or transport of the appliance.
- d) Failure of the appliance due to being incorrectly installed and non-compliant to the operation manual instructions, unless installed by a Marren authorised engineer.
- e) Where periodic maintenance, repair or replacement of parts has been carried out by a non Marren authorised engineer.
- f) Replacement of consumables through wear and tear which includes, but is not limited to, glass door, base tray, stirrer covers, lamps, air filters and plug fuses.
- g) Where the model number has been altered, deleted, removed or made illegible, deliberately.

CONDITIONS

- a) All repairs during the warranty period must be completed by an authorised engineer of Marren, either on-site or at an approved location. Any work carried out by a non-authorised engineer will invalidate the remaining term of the warranty.
- b) Any parts or components replaced under the warranty will be covered for the remainder of the warranty period.
- c) This warranty is non-transferable and only valid for the (“Original Purchaser”) during the 3 year warranty period.
- d) This warranty is only applicable to appliances sold and retained within the UK and installed with the correct electrical power supply. Please see the operations manual for more information.

How to claim: In the event that a repair is required under warranty, customers should contact the Marren service team on 01933 665313 or service@marren.co.uk. Alternatively, you can contact your original dealer who can help initiate your warranty claim.

 01933 665 313

 sales@marren.co.uk

 www.marren.co.uk

Marren Microwave Ltd., 40 Mallard Close, Earls Barton, Northampton, NN6 0JF