



LÖLSBERG



Funktions-, Bedienungs- und Montagehinweise für Portioniererduschanlagen

Herzlichen Glückwunsch! Mit dem Kauf unserer Portioniererduschanlage **i.ScoopShower** entscheiden Sie sich für mehr Hygiene und Geschmack, weniger Wasserbrauch und damit auch mehr Gewinn.

Funktions-/Bedienungshinweise:



- Durch Aufdrücken des Portionierers auf den Kugelkopf werden die Wasserventile geöffnet. Der Portionierer wird stets mit frischem Wasser von oben und unten gespült. Schmutziges Wasser läuft sofort ab. Auf der Innenseite des Portionierers findet eine Wasserverwirbelung statt, welche die Eisreste wegspült. Beim Abheben des Portionierers vom Kugelkopf schließen die Wasserventile durch den Wasserdruck wieder automatisch.
- **System täglich vor der ersten Verwendung und nach der letzten Verwendung reinigen/durchspülen (frisches Leitungswasser mindestens 1 Minute lang kontinuierlich laufen lassen)!**
- **Portionierer so lange spülen, bis nur noch sauberes Wasser an der Portioniererdusche herunterläuft!**
- Im täglichen Betrieb ohne Überlaufrohr arbeiten (ausgenommen Serie PERMANENT) und dieses nur für Reinigungszwecke verwenden. **Die Wasseraustrittslöcher dürfen nicht in verunreinigtem Wasser stehen.** Beim Reinigen ggfs. den gelochten Siebteiler und das Gummiabklopfprofil entfernen.
- **Portioniererduschanlage täglich reinigen/desinfizieren und in ausreichenden Zeitabständen Portioniererdusche demontieren und auch von innen reinigen/desinfizieren/entkalken (keine „aggressiven“ Reinigungs-, Desinfektions-, Entkalkungsmittel etc. verwenden)!**

Montagehinweise:



- **Überprüfen Sie vor der ersten Inbetriebnahme des Systems alle Wasseranschlüsse auf Dichtigkeit und korrekte Installation gemäß geltender technischer Normen und Richtlinien (z.B. incl. Sicherungskombination / Rückflussverhinderer mit Belüfter etc.) und stellen Sie sicher, dass es keine undichten Stellen gibt!**
- **Wasserdruckminderer (idealer Wasserdruck 2-3 bar), Wasserabstelhahn und Wasserrückflussverhinderer vorschalten!**
- **Wasserzulauf nachts und/oder bei Abwesenheit abstellen!**
- **Stellen Sie zu jedem Zeitpunkt einen freien Wasserabfluss sicher um zu vermeiden, dass Verunreinigungen durch die Löcher/Öffnungen an den Sprühköpfen ins Innere der Portioniererdusche gelangen können!**
- **System vor der ersten Verwendung reinigen/durchspülen (frisches Leitungswasser mindestens 3 Minuten lang kontinuierlich laufen lassen)!**
- **Duschköpfe nicht gegen den Uhrzeigersinn drehen, da sich dadurch die Schraubverbindung mit dem Standrohr lösen und die Portioniererdusche undicht werden kann!**

926001

925001

921001

920001

920920



910908

920801

920810

920801

920811

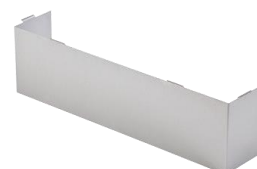

920212

910909

910901

920213

920922





LÖLSBERG



Operating and fitting instructions for spray rinsing devices for ice-cream scoops and dishes

Congratulations! You have chosen more hygiene, more taste, less water consumption and more profit by purchasing **i.ScoopShower** – our spray rinsing devices for dishes.

Operating instructions:



- The water valves at the top and bottom are opened by pressing the disher on the spherical head. The disher is always rinsed with fresh water from above and below. Dirty washing water runs away immediately. The water on the inside of the scoop is swirled around. This rinses off the food residuals. On removing the scoop from the spherical head the water valves are automatically closed again by the water pressure.
- **Let system run continuously for 1 minute at least once a day before starting operation and after finishing operation for the day!**
- **Rinse disher until only clean water runs down along the spray rinsing unit!**
- Do not use the overflow pipe (except for PERMANENT series) during daily operation. Application of the overflow pipe only for cleaning purposes. **The water discharge holes are not allowed to stand in dirty water.** The tap-off section and straining disc can be removed to clean the rinsing device.
- **Clean/sanitize complete spray rinsing device at least once every day and disassemble spray rinsing unit in sufficient time intervals to clean/sanitize/decalcify it from inside and outside (don't use "aggressive" detergents, cleansers, bleaches, decalcifiers, etc.)!**

Fitting instructions:



- **Check correct fitment of all threads and installation according to your local technical regulations and norms (e.g. incl. backflow-preventer with air gap) and make sure there are no leakages before using the system!**
- **Install a water pressure reducer (ideal water pressure 2-3 bars), a ball tap and a water-backflow-preventer!**
- **Close the water supply line during night and/or absence!**
- **Ensure at all times a free water drainage in order to avoid the water discharge holes from being contaminated towards the inside!**
- **Let system run continuously for at least 3 minutes before starting first operation in order to clean the system before using!**
- **Don't turn shower heads to the left. This could loosen the connection between the shower heads and the stand tube and make the spray rinsing unit leaking!**

920908

920804

920814

920214

930958

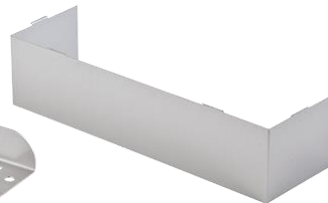

920989

920991

920901

920993

920999

930957

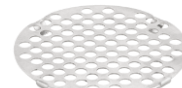

920994

920995

920996

920997

930962

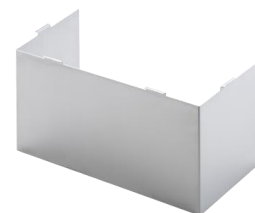



LÖLSBERG



920008 – 921008 – 925008 - 926008 / 920009 – 921009 – 925009 - 926009

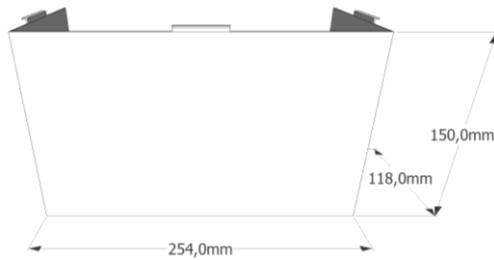
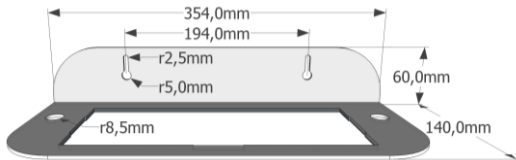
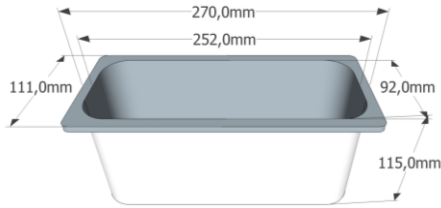

1/2"

1/2"



1/2"

1/2"

920801 / 920811

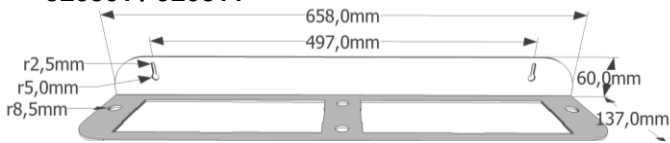

920006 – 921006 – 925006 - 926006 / 920007 – 921007 – 925007 - 926007

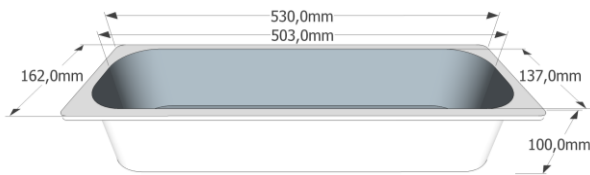

1/2"

1"

1/2"



1/2"

1"

1/2"



LÖLSBERG



920998 / 920020 – 921020 – 925020 - 926020 / 920029 – 921029 – 925029 - 926029

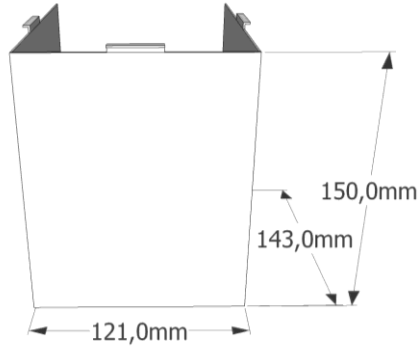
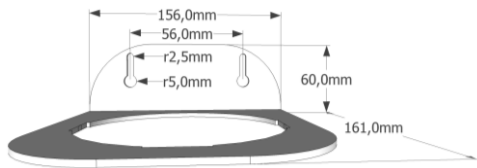
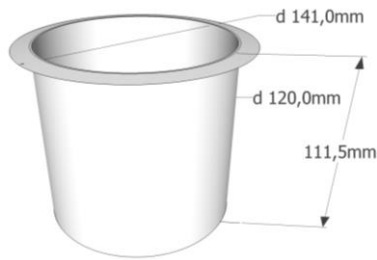

920993

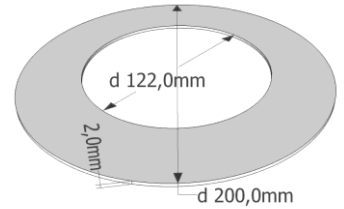

920024 – 921024 – 925024 - 926024 / 920027 – 921027 – 925027 - 926027

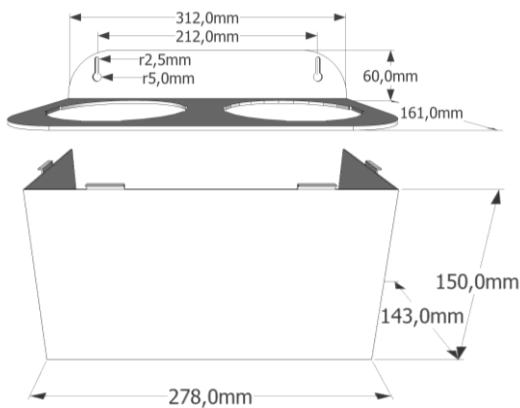

Weitere Informationen finden Sie auf unseren Webseiten www.loelsberg.de oder www.loelsberg.com. Natürlich können Sie uns bei Fragen auch gerne direkt kontaktieren unter +49 (0) 9305 98978-0. You can find further information on our websites www.loelsberg.de or www.loelsberg.com. Of course you are also welcome to contact us directly at +49 (0) 9305 98978-0.